

# SUN2000 (8KTL-28KTL) Quick Installation Guide

Issue: 13  
Part Number: 31505445  
Date: 2015-08-03

HUAWEI TECHNOLOGIES CO., LTD.



**NOTICE**

1. Before you install the devices, closely read the *SUN2000 (8KTL-28KTL) User Manual* to get familiar with product information and precautions. To locate the user manual, log in to <http://support.huawei.com/carrier/> and browse or search for SUN2000 on the **Product Support** page.
2. Use insulated tools.

Inverter Model	Weight
SUN2000-8KTL/10KTL/12KTL	40 kg
SUN2000-15KTL/17KTL/20KTL/23KTL/28KTL	48 kg

# 1 System Installation

Determine the installation position.

Unit: mm

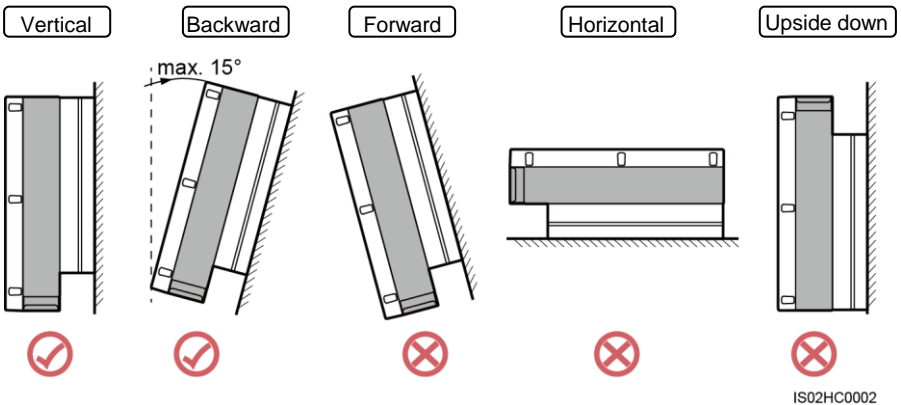
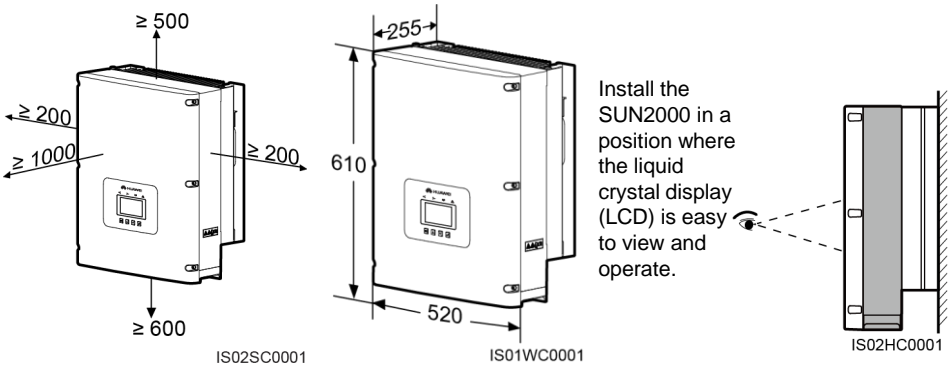

# Installing an Inverter (support-mounting is used as an example)

1. Determine the hole positions on the support based on rear panel dimensions.

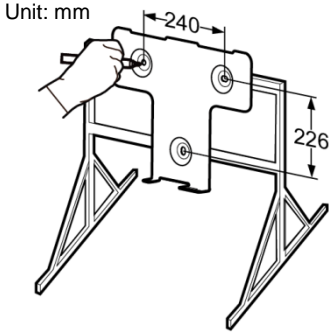

IS01HC0016

2. Drill holes.

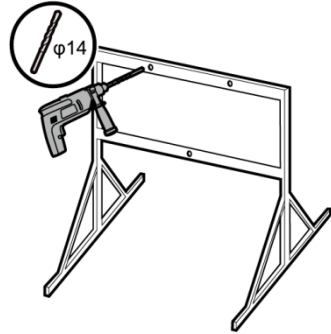

IS01HC0017

3. Secure the rear panel.

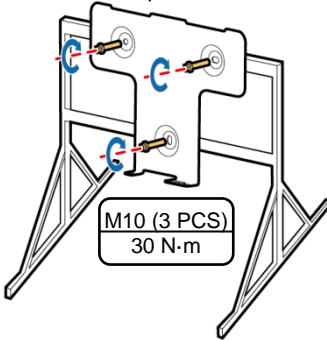

IS01HC0012

4. Mount the inverter on the rear panel.

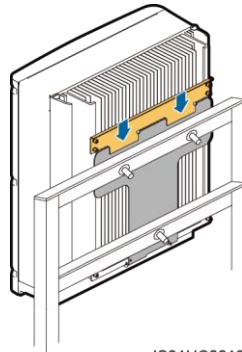

IS01HC0013

5. Tighten hexagon bolts.

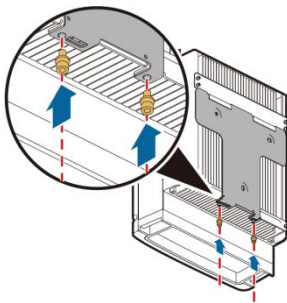

6. (Optional) Install an anti-theft lock.

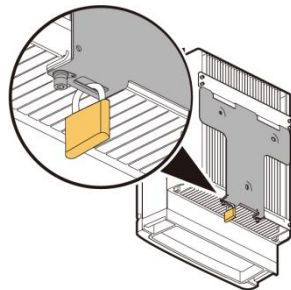

## NOTE

1. The antitheft lock is prepared by customers.
2. For details about wall-mounting the device, see the *SUN2000 (8KTL-28KTL) User Manual*.

## 2 Electrical Connection

1. Install a ground cable.

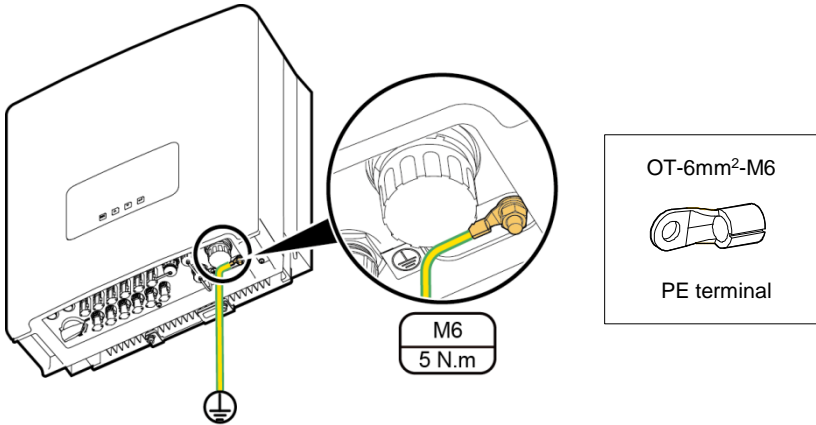

IS02IC0001



### NOTE

1. It is recommended that the ground cable be connected to a nearby ground position.
2. To enhance the corrosion resistance performance of the PE terminals, apply silica gel on them after connecting the ground cable.

2. Install AC output power cables.

Inverter Model	Cross-sectional Area of the Cable (Recommended)
SUN2000-8KTL/10KTL/12KTL	4.0 mm <sup>2</sup> (12 AWG)
SUN2000-15KTL/17KTL/20KTL/23KTL/28KTL	6.0 mm <sup>2</sup> (10 AWG) / 10.0 mm <sup>2</sup> (8 AWG)



### NOTE

The table lists only the recommended cable specifications. For more information about cable specifications, see the *SUN2000 (8KTL-28KTL) User Manual*.



### NOTICE

1. Do not use solid conductor hard cables.
2. 3-core outdoor cables (L1, L2, L3) are configured for the SUN2000-28KTL and 4-core outdoor cables (L1, L2, L3, and N) are for other models.

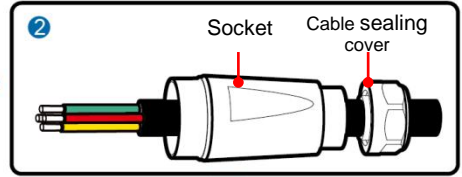
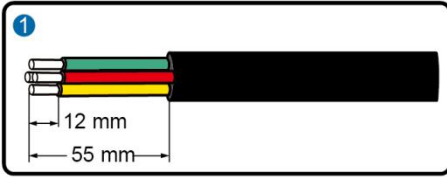

**⚠ NOTICE**  
 The N cable is inserted into hole 4. Do not insert L1/L2/L3 into

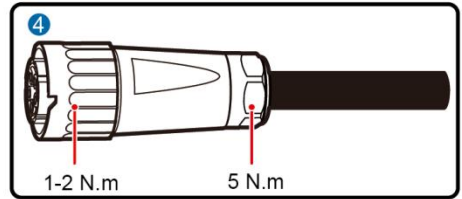
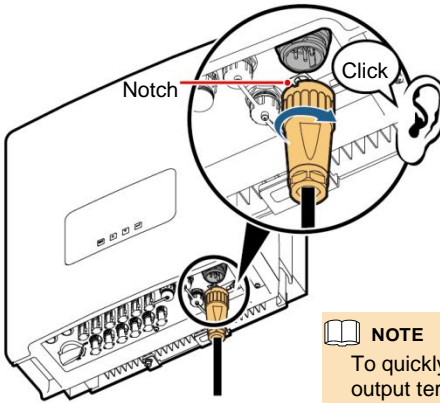
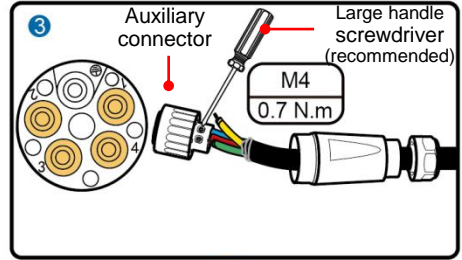

**📖 NOTE**  
 To quickly connect the AC output connector to the AC output terminal of the inverter, keep the notch of the connector facing exactly to the operator.

**⚠ NOTICE**  
 Ensure that the AC output connector is securely connected. Otherwise, the connector may be damaged after the inverter has been running for a long time.

3. Install DC input power cables.

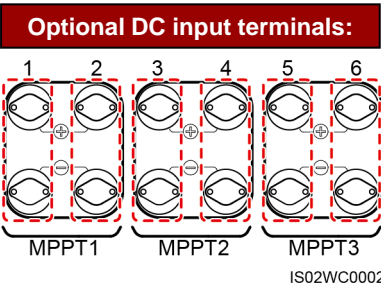

Number of Inputs	8KTL-12KTL	15KTL-28KTL
1	Connects to any one route	Connects to any one route
2	Connects to routes 1 and 3	Connects to routes 1 and 3
3	Connects to routes 1, 2, and 3	Connects to routes 1, 3, and 5
4	Connects to routes 1, 2, 3, and 4	Connects to routes 1, 2, 3, and 5
5	N/A	Connects to routes 1, 2, 3, 4, and 5
6	N/A	Connects to routes 1, 2, 3, 4, 5, and 6

## Positive and negative metal terminals:

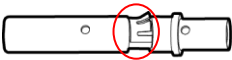

Positive metal terminal (female)

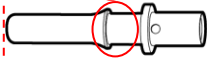

Negative metal terminal (male)

IS02WC0003

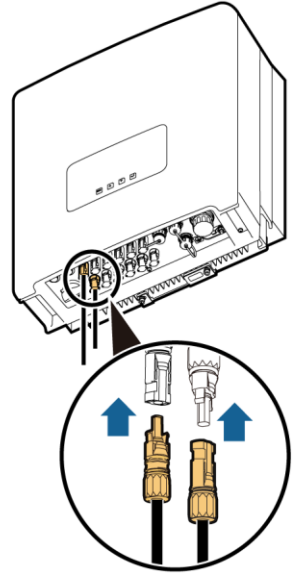
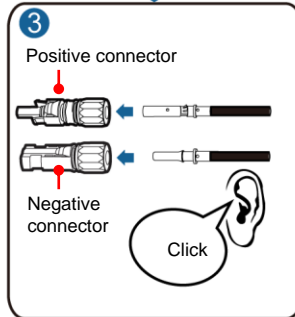
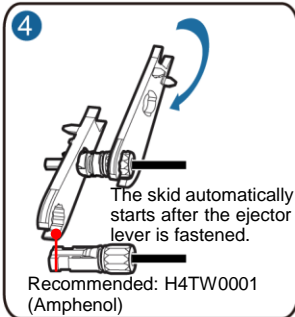
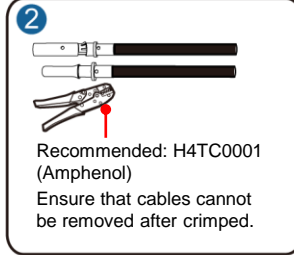
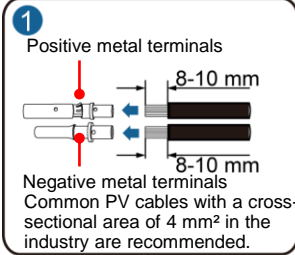

IS02IC0003

### ⚠ NOTICE

1. Pull back the DC input power cables to check whether the cables would be disconnected.
2. If DC input power cables are reversely connected and the DC switch is ON, do not turn off the DC switch immediately. Otherwise, the equipment may be damaged. You can disconnect the DC input power cable on the PV string side or wait until the PV string voltage reduces to a value within the safety range. Then, turn off the DC switch, remove the positive and negative connectors, and rectify the connection.

#### 4. Install an RS485 communications cable.

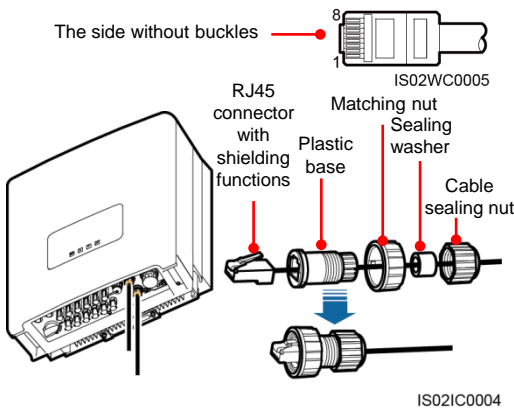

No.	Color	Pin Definition
1	White and orange	RS485A, and RS485 differential signal+
2	Orange	RS485B, and RS485 differential signal-
3	White and green	PGND
4	Blue	RS485A, and RS485 differential signal+
5	White and blue	RS485B, and RS485 differential signal-
6	Green	PGND
7	White and brown	PGND
8	Brown	PGND

### 3 Installation Verification

1. Check that all screws, especially the screws used for electrical connections, are secured.	Passed <input type="checkbox"/> Failed <input type="checkbox"/>
2. Check that all circuit breakers are switched to OFF.	Passed <input type="checkbox"/> Failed <input type="checkbox"/>
3. Check that the ground cable is securely connected and no short circuit occurs.	Passed <input type="checkbox"/> Failed <input type="checkbox"/>
4. Check that AC output power cables are connected correctly and securely (the N wire is connected to hole 4, and L1/L2/L3 can be connected to any hole of 1/2/3; for details, see 2.2 Install AC output power cables), with no short circuit.	Passed <input type="checkbox"/> Failed <input type="checkbox"/>
5. Check that DC input power cables are connected correctly and securely, with no short circuit.	Passed <input type="checkbox"/> Failed <input type="checkbox"/>
6. Ensure that idle DC input terminals are sealed.	Passed <input type="checkbox"/> Failed <input type="checkbox"/>
7. Check that the idle USB and RS485 ports are plugged with waterproof plugs.	Passed <input type="checkbox"/> Failed <input type="checkbox"/>

### 4 System Power-on

1. Switch on the AC circuit breaker between the SUN2000 and the power grid.
2. Ensure that the DC Switch at the bottom of the SUN2000 is ON.
3. (Optional) Measure the temperatures at the joints between the DC terminals and the connectors.

### 5 Setting Monitoring Parameters



#### NOTE

1. If no data collector is used, set the following parameters before connecting the SUN2000 to the power grid. For the other parameter settings, see the *SUN2000 (8KTL-28KTL) User Manual*. If a data collector is used, see the *SmartLogger1000 User Manual* for the parameter settings.
2. The preset password for **Common User**, **Advanced User**, and **Special User** is **000001**. Use the preset password to log in to the SUN2000 for the first time and then change the password to a new one to ensure the account security.

Main Menu	Second-Level Menu	Third-Level Menu	Fourth-Level Menu	Setting
Wizard	Language	-	-	Set based on site requirements.
	Date&Time	Date	-	Set based on site requirements.
		Time	-	Set based on site requirements.
	Grid Code	-	-	<ul style="list-style-type: none"> <li>● China medium-voltage power grid, choose <b>CHINA-MV480</b>.</li> <li>● China low-voltage power grid, choose <b>NB/T 32004</b>.</li> </ul> For other cases, see the Appendix.
Main Menu	Settings	Isolation(Advanced User)	Input Grounded, With TF	● When the PV- is grounded, an isolation transformer should be connected. Set <b>Isolation</b> to <b>Input Grounded, With TF</b> .
			Input Ungrounded, Without TF	
			Input Ungrounded, With TF	● When the PV- is not grounded, set <b>Isolation</b> to <b>Input Ungrounded, Without TF</b> or <b>Input Ungrounded, With TF</b> .



## Appendix: Power Grid Standard Code Mapping Table

No.	Power Grid Standard Code	Country and Condition	No.	Power Grid Standard Code	Country and Condition
1	CHINA-MV480	China medium-voltage power grid	24	IEC61727-MV480	IEC medium-voltage power grid
2	NB/T 32004	China low-voltage power grid	25	VDE 0126-1-1-BU	Bulgaria low-voltage power grid
3	UTE C 15-712-1(A)	France low-voltage power grid	26	VDE-AR-N-4105	Germany low-voltage power grid
4	UTE C 15-712-1(B)	Islands of France 230 V 50 Hz	27	BDEW-MV480	Germany medium-voltage power grid
5	UTE C 15-712-1(C)	Islands of France 230 V 60 Hz	28	BDEW-MV	Germany medium-voltage power grid (400 V AC)
6	UTE C 15-712-1-MV480	France medium-voltage power grid	29	TAI-PEA	Thailand low-voltage power grid (PEA)
7	G59-England-MV480	UK 480 V Medium-voltage power grid ( $I > 16$ A)	30	TAI-MEA	Thailand low-voltage power grid (MEA)
8	G59-England	England 230 V power grid ( $I > 16$ A)	31	TAI-PEA-MV480	Thailand medium-voltage power grid (PEA)
9	G59-Scotland	Scotland 240 V power grid ( $I > 16$ A)	32	TAI-MEA-MV480	Thailand medium-voltage power grid (MEA)
10	G83-England	England 230 V power grid ( $I < 16$ A)	33	EN 50438-DK	Denmark medium-voltage power grid
11	G83-Scotland	Scotland 240 V power grid ( $I < 16$ A)	34	Japan(50Hz)	Japan power grid (50 Hz)
12	CEI0-21	Italian low-voltage power grid	35	Japan(60Hz)	Japan power grid (60 Hz)
13	CEI0-16	Italian medium-voltage power grid	36	EN50438-TR-MV480	Turkey medium-voltage power grid
14	IEC61727	IEC low-voltage power grid	37	EN50438-TR	Turkey low-voltage power grid
15	VDE 0126-1-1-GR(A)	Mainland of Greece low-voltage power grid	38	C10/11	Belgium low-voltage power grid
16	VDE 0126-1-1-GR(B)	Islands of Greece low-voltage power grid	39	C11/C10-MV480	Belgium medium-voltage power grid
17	EN50438-CZ	Czech Republic low-voltage power grid	40	Philippines	Philippines low-voltage power grid
18	RD1699	Spanish low-voltage power grid ( $P_n < 100$ kW)	41	Philippines-MV480	Philippines medium-voltage power grid
19	RD661	Spanish low-voltage power grid ( $P_n > 100$ kW)	42	EN50438-NL	Netherlands low-voltage power grid
20	AS4777	Australia low-voltage power grid	43	Custom(50Hz)	Reserved
21	AS4777-MV480	Australia medium-voltage power grid	44	Custom(60Hz)	Reserved
22	NRS-097-2-1	South Africa low-voltage power grid	45	Custom-MV480 (50Hz)	Reserved
23	NRS-097-2-1-MV480	South Africa medium-voltage power grid	46	Custom-MV480 (60Hz)	Reserved



### NOTE

Grid codes are subject to change. The listed codes are for your reference only.

**HUAWEI TECHNOLOGIES CO., LTD.**

Huawei Industrial Base Bantian Longgang

Shenzhen 518129

People's Republic of China

[www.huawei.com](http://www.huawei.com)